



## Phoulds

Design by Allermuir

Elegance, poise and comfort were the words that guided the development of the Phoulds seating range. The development calls for the meticulous joining of two pressed plywood shells to create the chair's structure. The seat structure is then lined

with a distinctive six panel upholstery style that provides the user with sumptuous levels of comfort. In addition the outer shell can be fully upholstered as an option. The range offers the diversity of both high and mid back shells and two distinctive

support frames. The style of the chair makes a strong visual statement whilst its fine detailing and traditional material selection make it an excellent choice across workplace hospitality and retail environments.



PH1



PH1U



PH11U



PH2



PH2U



PH12U



PH3



PH3U



PH13U



PH4



PH4U



PH14U



PH7



PH7U

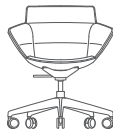

PH17U

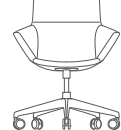

PH8

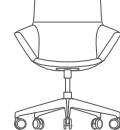

PH8U



PH18U



## Design Allermuir

Our team of talented in house designers are responsible for creating elegant, innovative furniture designs which not only look beautiful, but minimise the impact on the world around us.

## Standard Features

- (\* - Selected models only)
- Beech shell\*
- Soft quilted upholstery\*
- 6 panel upholstery with CMHR foam\*
- Fully upholstered outer shell\*
- Tubular steel frame with self leveling glides\*
- 4-star base with felt glides\*
- Plastic under seat shroud\*
- 5-star base with castors\*
- Seat height adjustment\*

## Optional Features

- Plastic self leveling glides with felt\*
- Two-tone upholstery

## Dimensions

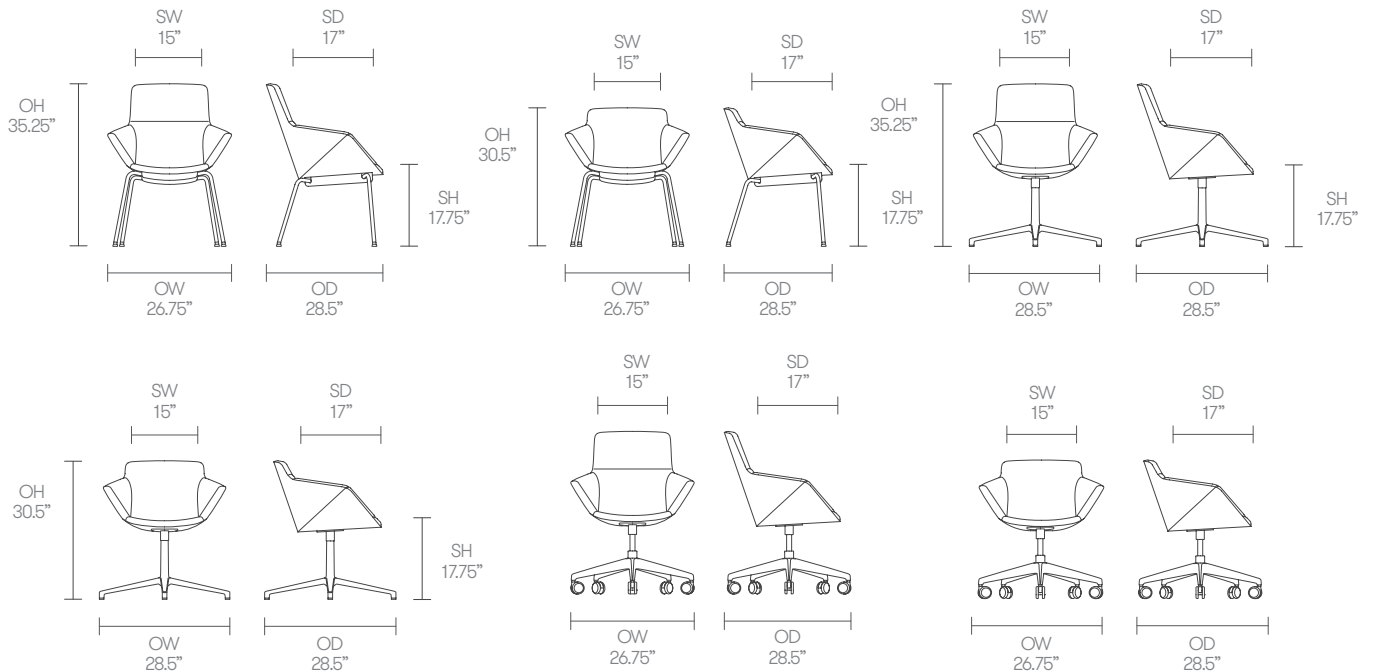

## Environmental Performance

### Material Content

Components are constructed of the following

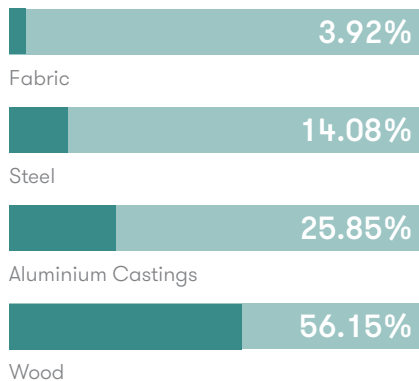

### Recycled Content

Contains up to 35.00% of Recycled Material

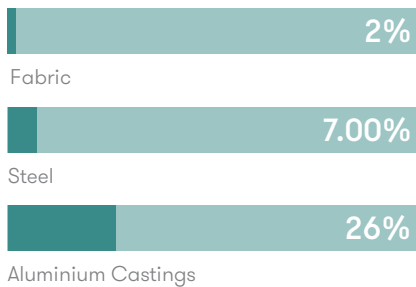

### Recyclability

The range is 100% recyclable

# 100%

## Finish Options

Tubular steel frame available in either Polished Chrome or Black powder coat\*

4-star and 5-star base's available in Polished Aluminum\*

Outer shell is available in either Beech or Walnut Veneer that is clear lacquered

Beech outer shell can be stained or colored in finishes from the Allermuir standard collection

Phoulds can be upholstered in a broad range of contract upholstery fabrics, vinyls and leathers from Allermuir standard upholstery collection

### Standard Metal Finishes



Black power coat



Polished Chrome

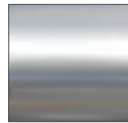

Polished Aluminum

### Standard Wood Finishes



Beech



Walnut Veneer

### Color Washes based on Beech



White as Snow Wash



Back to Black Wash



Slate Grey Wash



Smoke Grey Wash

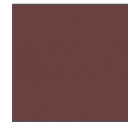

Vintage Red Wash



Ruby Red Wash



Fern Green Wash



Peacock Green Wash

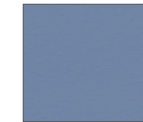

Blue Skies

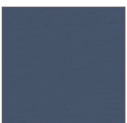

Sapphire Blue Wash



Orange Crush Wash



Mellow Yellow Wash



Nut Brown Wash

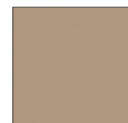

Turtle Dove Wash



Sherbert Yellow Wash



Blush Pink Wash

### Wood Stains based on Beech



Clear



White Oak



American Cherry



American Walnut

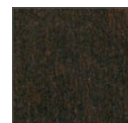

Dark Walnut



Wenge